



Be ahead



DEIMOS AC A



• Product

• ADVANTAGES
• PLUS

• CONTROL UNIT
• TECHNICAL FEATURES

• ACCESSORIES

• DISCOVER U-LINK



Range of residential operators for sliding gates weighing up to 800 Kg. Electromechanical limit switch, 230V supply power.

DEIMOS AC A

Code	Name		Description
P925230 00002	DEIMOS AC A600		Operator 230 V for sliding gates up to 600 kg in weight. Leaf speed 9 m/min.
P925230 00005	DEIMOS AC A600 SQ		Operator 230 V for sliding gates up to 600 kg in weight. Leaf speed 9 m/min.
P925230 00003	DEIMOS AC A600 V		Operator 230 V for sliding gates up to 370 kg in weight. Leaf speed 11 m/min.
P925230 00001	DEIMOS AC A600 120		Operator 120 V for sliding gates up to 600 kg in weight. Leaf speed 9 m/min.
P925230 00004	DEIMOS AC A600 120 V		Operator 120 V for sliding gates up to 370 kg in weight. Leaf speed 11 m/min.
P925231 00002	DEIMOS AC A800		Operator 230 V for sliding gates up to 800 kg in weight. Leaf speed 9 m/min. Brake and clutch electronically managed. Electromechanical limit switch
P925231 00005	DEIMOS AC A800 SQ		Operator 230 V for sliding gates up to 800 kg in weight. Leaf speed 9 m/min.
P925231 00003	DEIMOS AC A800 V		Operator 230 V for sliding gates up to 400 kg in weight. Leaf speed 11 m/min. Brake and clutch electronically managed. Electromechanical limit switch
P925231 00001	DEIMOS AC A800 120		Operator 120 V for sliding gates up to 800 kg in weight. Leaf speed 9 m/min. Brake and clutch electronically managed. Electromechanical limit switch
P925231 00004	DEIMOS AC A800 120 V		Operator 120 V for sliding gates up to 400 kg in weight. Leaf speed 11 m/min. Brake and clutch electronically managed. Electromechanical limit switch
R925281 00002	DEIMOS AC KIT A600 FRA		Complete kit 230V for sliding gates weighing up to 600Kg. Leaf speed 9 m/min and electromechanical limit switch. The kit contains: 1 operator DEIMOS AC A600, 2 remote controls MITTO 4CH, 1 blinker RADIUS B LTA, 1 pair of photocells DESME A.15.

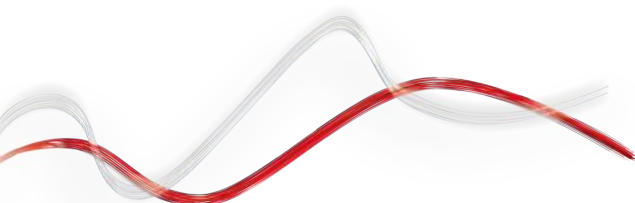



DEIMOS AC A



• Product

• ADVANTAGES
• PLUS

• CONTROL UNIT
• TECHNICAL FEATURES

• ACCESSORIES

• DISCOVER U-LINK

DEIMOS AC A

Code	Name	Description
R925283 00002	DEIMOS AC KIT A800 FRA 	Complete kit 230V for sliding gates weighing up to 800Kg. Leaf speed 9 m/min and electromechanical limit switch. The kit contains: 1 operator DEIMOS AC A800, 2 remote controls MITTO 4CH, 1 blinker RADIUS B LTA, 1 pair of photocells DESME A.15.

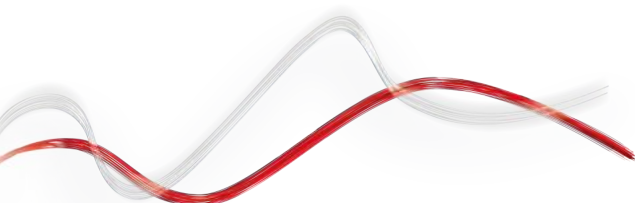

· Product

· **ADVANTAGES**
· **PLUS**· CONTROL UNIT
· TECHNICAL FEATURES

· ACCESSORIES

· **DISCOVER U-LINK**

ADVANTAGES

Fixing of casing with front screws: in the new Deimos AC A line, the casing is fixed by means of two screws located in the front of the automation. This arrangement makes installation and casing removal and fitting operations easier, facilitating the installer's work.

Lever release: Motor release is made easier thanks to the new release lever that ensures quicker, easier and more intuitive operation.

Simplified and intuitive wiring: the SHYRA AC and SHYRA-F AC control units have standardised terminal blocks with different colours depending on the input and output function blocks for maximum ease of connection of operators and accessories.

PLUS



Release lever with personalised key: the release lever simplifies motor release and the personalized key ensures its uniqueness, for better safety



Front screws: this arrangement of the casing screws offers ease and convenience during installation and maintenance, even when there is limited space.

• Product

• ADVANTAGES
• PLUS

• **CONTROL UNIT**
• **TECHNICAL FEATURES**

• ACCESSORIES

• **DISCOVER U-LINK**

SHYRA AC Built-In



- Application: control panel for one operator for slide and swing gates, roll-up gates and overhead doors
- Board power supply: 230V single-phase
- Operator power supply: 230V single phase 500W max
- Main features: removable terminal blocks, settings controlled by potentiometers, LED-based fault reporting and incorporated dual channel receiver, two safety verified inputs, one of wich dedicated to 8k2 safety edge.
- Main functions: fast closing, pulse blocking.

SHYRA-F AC Built-In



- Application: control panel for one operator for slide and swing gates, roll-up gates and overhead doors
- Board power supply: 230V single-phase
- Operator power supply: 230V single phase 500W max
- Main functions: fast closing, pulse blocking.
- Main features: removable terminal blocks, settings controlled by potentiometers, LED-based fault reporting and incorporated dual channel receiver, electronic clutch management via trimmer, two verified safety inputs, one of wich dedicated to 8k2 safety edge.

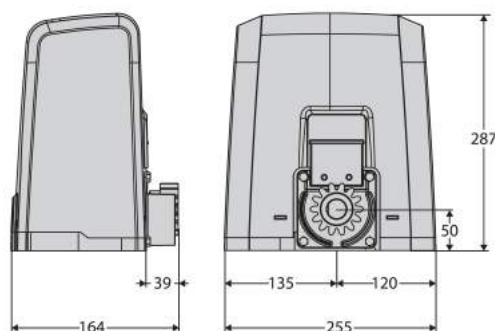

	DEIMOS AC A600	DEIMOS AC A600 SQ	DEIMOS AC A600 V	DEIMOS AC A600 120	DEIMOS AC A600 120 V	DEIMOS AC A800	DEIMOS AC A800 SQ	DEIMOS AC A800 V	DEIMOS AC A800 120	DEIMOS AC A800 120 V
Impact reaction	mechanical clutch					electronic clutch				
Control unit	SHYRA AC	Not present	SHYRA AC			SHYRA-F AC	Not present	SHYRA-F AC		
Board power supply	230 V									
Power supply	230 V			120 V			230 V			120 V
Power input	400 W					300 W	400 W		300 W	
Max Leaf	600 kg		370 kg	600 kg	370 kg	800 kg		400 kg	800 kg	400 kg
Gate speed	9 m/min		11 m/min	9 m/min	11 m/min	9 m/min		11 m/min	9 m/min	11 m/min
Type of limit switch	electromechanical									
Locking	mechanical									
Release	lever-operated with personal key									
Frequency of use	semi-intensive									
Environmental conditions	from -20 °C to 55 °C									
Protection rating	IP24									







• Product

• ADVANTAGES
• PLUS

• CONTROL UNIT
• TECHNICAL FEATURES

• **ACCESSORIES**

• DISCOVER U-LINK

	Code	Name	Description
	D221073	CP	Plastic rack, 4-module, cross-section 22 x 22 mm, length 1 m, screw-fitted into slots Portata massima 600 Kg.
	N999320	CVZ-S	Steel rack, 4-module, cross-section 30 x 8 mm, length 1 m, screw-fitted on supports (supplied) Portata massima 800 kg.
	D571054	CFZ	Galvanized steel rack for welding, 22x22 mm, 4-module, cross-section from 2 m Portata massima 1000 kg.
	D571053	CVZ	Steel rack, 4-module, cross-section 30 x 12 mm, length 1 m, screw-fitted on supports (supplied) Portata massima 2000 Kg.
	N999151	SFD	Base plate for DEIMOS series (supplied with operator)
	N190104	BIR C	Rubber safety edge (H 30 mm), price per m
	P111052	CM1700	Mechanical safety edge, length 1.7 m
	P111053	CM2000	Mechanical safety edge, length 2 m
	N190106	STR	Pair of infrared STR sensors for ERIS A30
	P111401 00001	VENTIMIGLIA NS	Infrared device for BIR C or BAR C safety edges (conforms to EN 12978 Standard)
	P111400	FLC 8K2	Interface for connecting one or more 8K2 type edges
	D113748 00002	RADIUS B LTA 230 R1	Flashing light with incorporated antenna for motors with power supply 230 V.
	D113749 00002	RADIUS B LTA 230 R2	Flashing light without incorporated antenna for motors with power supply 230 V.
	P123025	B 00 R02	Wall mounting for B LTA series flashing beacons
	P123026	B 00 R01	Metal guard for B LTA
	D111904	MITTO B RC802 R1	Transmitter with 2 channels. Range 50/100 m. Power supply 12 V with 1 battery type 23 A







• Product

• ADVANTAGES
• PLUS

• CONTROL UNIT
• TECHNICAL FEATURES

• **ACCESSORIES**

• DISCOVER U-LINK

	Code	Name	Description
	P121016	RB	4-channel wall-mounted radio control with rolling code
	P121025	Q.BO PAD	Vandalproof outdoor digital button panel. Metal structure and s/steel buttons. Compatible with WIEGAND protocol, it ensures maximum system safety as it does not directly control gate opening.
	P121022	Q.BO KEY WM	Key selector for outdoor use with double contact.
	P121023	Q.BO KEY WM AV	Vandalproof key selector with double contact, for outdoor use. Metal structure. Vandalproof key selector with metal structure.
	P111526	DESME A15	Pair of self-aligning photocells. Range 30 m. Power supply 24 V ac/dc. Pair of self-aligning photocells. Range 30 m. Power supply 24 V ac/dc.
	P111527	DESME A15 O	Pair of photocells adjustable 40 ° horizontally and 10 ° vertically. IR signal synchronised to prevent any risk of blinding. Range 30 m. Power supply 24 V ac/dc.
	P111537	ERIS A30	Pair of wireless photocells with possibility of management of an active infrared or resistive safety edge adding STR and BIR C or BAR C profiles. Possibility of adjusting the beam 180 ° horizontally and vertically 20 °. Range 30 m. Power supply 24 V ac/dc.
	P903018	PHP	Pair of aluminium posts for THEA/DESME series photocells Height 522 mm
	D831081	CMS	Sign

· Product

· ADVANTAGES
· PLUS

· CONTROL UNIT
· TECHNICAL FEATURES

· ACCESSORIES

· DISCOVER U-LINK

What is U-Link?

The innovative technology that gives you new power

An exclusive Bft innovation: U-Link (Universal Link) is an exclusive Bft platform that allows the creation of technological ecosystems. In Home Automation Access, it allows communication with all the home access automation devices of any brand. So you save time and can control everything with ease, without any worries.

It is intuitive

Easy to install and use

It is scalable

Allows an unlimited number of devices to be added

It is flexible

Allows the creation of groups of interconnected products

It is practical

Works with or without a web connection

It is functional

Parameters can be controlled remotely via dedicated applications

· Product

· ADVANTAGES
· PLUS

· CONTROL UNIT
· TECHNICAL FEATURES

· ACCESSORIES

· DISCOVER U-LINK

All in one scheme: discover this amazing technology

A unique platform **allowing the creation of technological ecosystems** offering a wide range of solutions for different sectors.

Thanks to the B-Eba cards and the Clonix U-Link receiver, this proprietary platform featured by Bft products adapts to any protocol and access automation product (even BFT, non-native U-Link or non-BFT products), and is used in various sectors. Each device thus becomes smart and can be interconnected with other systems, thanks to a language that becomes universal.

U-Base 2



Software to install and easily and comfortably carry out maintenance and identify any malfunction of U-link compatible operators.

U-SDK



U-SDK is the innovative application that can make Bft automation systems compatible and easily integrated with a BMS network for the supervision of buildings.



Magistro

An innovative and easy to install system for easily managing all home automation systems.



U-Control

U-Control is the application that helps the quick and easy integration of BFT automation systems in large building management systems.



Blue-Entry

Technology abreast of the times and attentive to daily needs: thanks to the use of U-link the house gate can now be opened with just your smartphone.



Clonix U-Link

Allows the connection of non-native U-Link products or non-Bft products to U-Link systems.

Bft operators, non-native U-Link products or a product belonging to other brands: can they be connected to U-Link? Yes, thanks to the Clonix receivers. Accessories that know no limits.

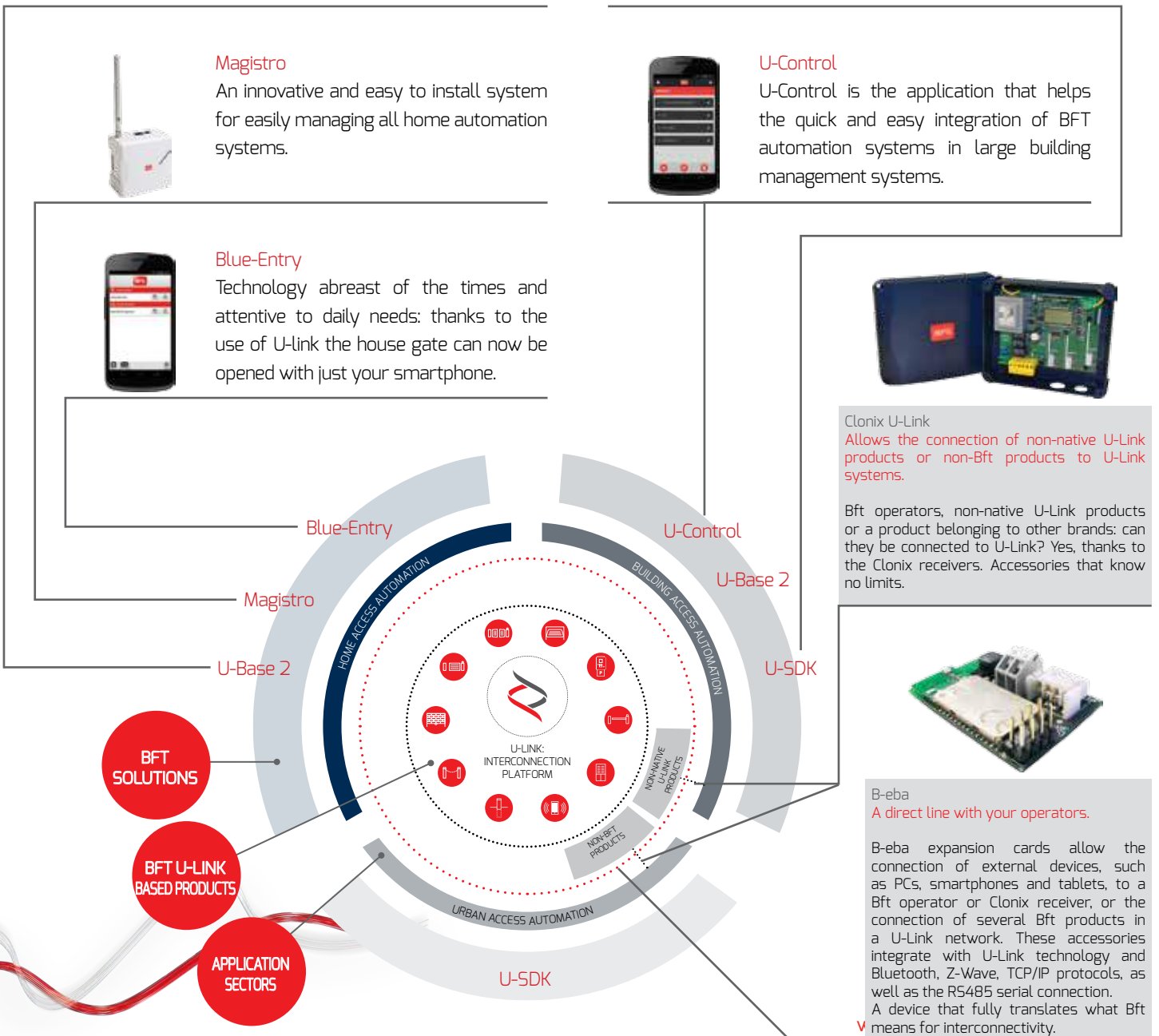

B-eba

A direct line with your operators.

B-eba expansion cards allow the connection of external devices, such as PCs, smartphones and tablets, to a Bft operator or Clonix receiver, or the connection of several Bft products in a U-Link network. These accessories integrate with U-Link technology and Bluetooth, Z-Wave, TCP/IP protocols, as well as the RS485 serial connection.

A device that fully translates what Bft means for interconnectivity.

