

USERS GUIDE MATRIX DIGITAL INDUCTIVE LOOP SENSORS

APPLICATIONS

The MATRIX Digital Inductive Loop Detector is the ideal solution for parking barrier control, motorized gates and doors, vehicle access control and industrial control systems.

The MATRIX is a high performance single or dual-channel vehicle detector packaged in a compact housing. The connection is made with a standard industrial 11-pin round connector.

The six versions listed below include single or dual-channel, and 3 possible power supplies:

10MATRIXS110	:	Single loop detector with 110 to 120 V AC power supply.
10MATRIXS220	:	Single loop detector with 220 to 240 V AC power supply.
10MATRIXS1224	:	Single loop detector with 12 to 24 V AC/DC power supply.
10MATRIXD110	:	Dual loop detector with 110 to 120 V AC power supply.
10MATRIXD220	:	Dual loop detector with 220 to 240 V AC power supply.
10MATRIXD1224	:	Dual loop detector with 12 to 24 V AC/DC power supply.

TECHNICAL SPECIFICATIONS

Technology	:	Inductive loop
Tuning	:	automatic
Detection mode	:	presence
Presence time	:	1 min to infinity (permanent presence) with 250 steps.
Pulse time output	:	100 ms or 500 ms
Inductance range	:	20 μ H to 1000 μ H
Frequency range	:	20 kHz to 130 kHz
Frequency steps	:	4 for single loop 2 for dual loop (for each loop)
Sensitivity (ΔL/L)	:	0.005% to 0.5% with 250 steps
Reaction time	:	25ms for single loop 50ms for dual loop(each channel)
Setup time at power on	:	8 s max by channel
Setup time after configuration	:	2s max by channel
Power supply (depending on model)	:	<ul style="list-style-type: none"> • 12-24 AC/DC \pm 10% • 230VAC \pm 10 % • 115VAC \pm 10 %
Power Frequency	:	48 to 62 Hz
Power Consumption	:	< 2.5 W
Temperature range	:	-22°F to 158°F [-30°C to +70 °C]

Degree of protection	:	IP40
2 Output relays (free potential change-over contact)	:	<ul style="list-style-type: none"> • Max contact voltage : 230 VAC ; • Max contact current : 5A (resistive).
LED indicators	:	<ul style="list-style-type: none"> • 1 green LED : power ; • 1 red LED : Loop status 1 ; • 1 red LED : Loop status 2.
Protections	:	<ul style="list-style-type: none"> • loop insulation transformer ; • Zener diodes ; • gas discharge clamping.
Connection	:	Standard 11-pin round connector 86CP11
Dimensions	:	3 in (H) x 1.5 in (W) x 3 in (D) [77mm (H) x 40mm(W) x 75mm(D)]
Weight	:	7 ounces [$<$ 200g]
Product compliance	:	R&TTE 1999/5/EC EMC 89/336/EEC FCC 47CFR15 IC RSS-210 Issue 5

DESCRIPTION OF THE SENSOR

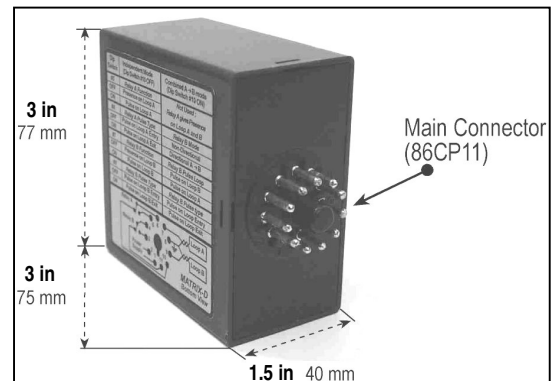
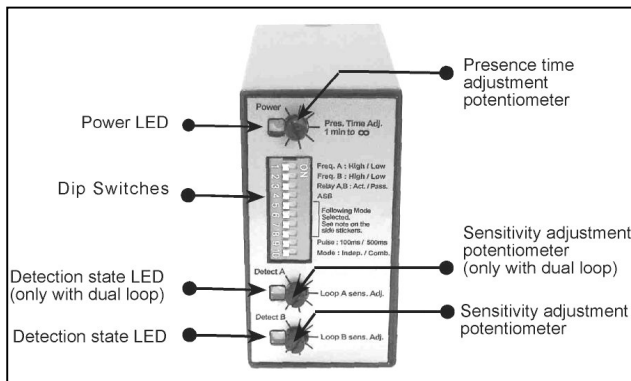

SAFETY PRECAUTIONS



- Shut off all power before attempting any wiring procedures.
- Maintain a clean & safe environment.
- Constantly be aware of traffic around the door or gate area.
- Always suspend traffic through the doorway or gate area when performing testing that may result in unexpected reactions by the door or gate.
- Always check placement of all wiring and components before powering up to insure that moving parts will not catch any wires and cause damage to equipment.

FCC COMPLIANCE

10MATRIXS110:	Matrix, Single Unit, 110 Volt AC supply	} (FCC ID: G9B-MATRIX) (IC: 4680A-MATRIX)
10MATRIXS220:	Matrix, Single Unit, 220 Volt AC supply	
10MATRIXS1224:	Matrix, Single Unit, 12-24 Volt AC/DC supply	
10MATRIXD110:	Matrix, Double Unit, 110 Volt AC supply	
10MATRIXD220:	Matrix, Double Unit, 220 Volt AC supply	
10MATRIXD1224:	Matrix, Double Unit, 12-24 Volt AC/DC supply	

The Digital Transmitters and Receivers comply with Part 15 of the FCC rules. Operation is subject to the following two conditions:
 1) This device may not cause harmful interference and;
 2) This device must accept any interference received including interference that may cause undesired operations.
 Changes or modifications not expressly approved by B.E.A., Inc. for compliance could void the user's authority to operate the equipment.

LOOP INSTALLATION TIPS

A . CABLE SPECIFICATIONS FOR LOOP AND FEEDER

- 16 AWG (1.5mm²) cross section area ;
- Multi-strand cable ;
- Insulation material : PVC or Silicone ;
- For the feeder cable, the wire must be twisted at least 15 times per yard for each cable.
- Feeder for long runs used for foil screened cable is recommended (earth at equipment end only)
- The feeder cable must be firmly fixed to avoid any false detection (max length: 330 feet (100 m)).
- Waterproof cable junction box is required.

B. LOOP GEOMETRY

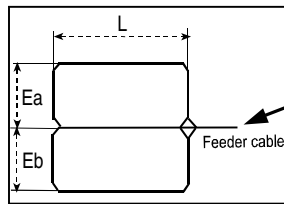

- When two adjacent loops are connected to a dual channel sensor, it is possible for these loops to share a common slot, if so required. As the channels are multiplexed, no interference will occur.
- Avoid large loops or long feeder [max 330 feet (100 m)], or else the sensitivity will be affected.

C. DETERMINATION OF THE NUMBER OF LOOP TURNS

- Measure the length (L) and width (Ea) of one loop. Multiply these numbers together to determine the loop surface area. See above drawing.
- For example, if L=10 ft, Ea= 3 ft, then the area = 30 ft²; 4 loop turns are recommended.
 or if L=2m, Ea=1m, then the area = 2 m²; 4 loop turns are recommended.

Recommended values for the turns:

Area		Number of turns
<32 ft ²	<3 m ²	4
32 – 54 ft ²	3 – 5 m ²	3
65 – 108 ft ²	6 – 10 m ²	2

WARNING:
 For conformity reasons, in any installation, the loop surface multiplied by the number of turns should not exceed **215** (for square feet); **20** (for square meters)



D. SLOT DEPTH

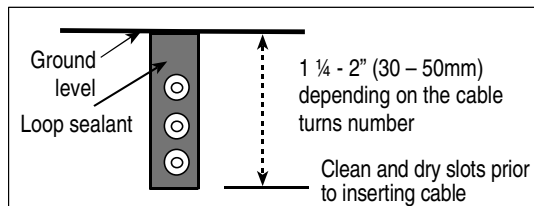

WARNING : Do not remove the grease on the connector's pins.

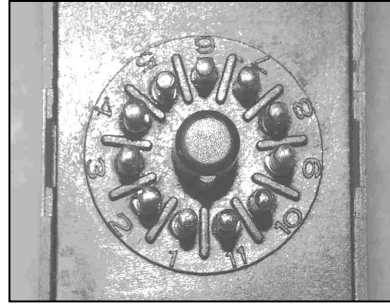

- Pin 1** : Power Supply
- Pin 2** : Power Supply
- Pin 3** : Relay 2 (NO)
- Pin 4** : Relay 2 (COM)
- Pin 5** : Relay 1 (NO)
- Pin 6** : Relay 1 (COM)
- Pin 7** : Loop A
- Pin 8** : Loop common and **connect to ground** \perp
- Pin 9** : Loop B
- Pin 10** : Relay 1 (NC)
- Pin 11** : Relay 2 (NC)



WARNING:
Pin #8 must be connected to the loop and to ground

I. THE 3 CONFIGURATIONS

- Configuration A : single loop detector (MATRIX-S) ;
- Configuration B : dual loop detector in independent mode (MATRIX-D with dip switch #10 OFF) ;
- Configuration C : dual loop detector in combined mode (MATRIX-D with dip switch #10 ON).

Dip Switch	Configuration A Single loop		Configuration B Dual loop in independent mode		Configuration C Dual loop in combined mode	
	OFF	ON	OFF	ON	OFF	ON
DS#1	See next table		High (loop A)	Low (loop A) [High -30%]	High (loop A)	Low (loop A) [High -30%]
DS#2	See next table		High (loop B)	Low (loop B) [High -30%]	High (loop B)	Low (loop B) [High -30%]
DS#3	Active mode	Passive mode	Active mode	Passive mode	Active mode	Passive mode
DS#4	ASB OFF	ASB ON	ASB OFF	ASB ON	ASB OFF	ASB ON
DS#5	Relay A : Presence on loop A	Relay A : Pulse on loop	Relay A : Presence on loop A	Relay A : Pulse on loop A	Not used	Not used
DS#6	Relay A : Pulse on loop A entry	Relay A : Pulse on loop A exit	Relay A : Pulse on loop A entry	Relay A : Pulse on loop A Exit	Relay B : Non-Directional mode	Relay B: Directional A→B mode
DS#7	Relay B : Presence on loop A	Relay B : Pulse on loop A	Relay B : Presence on loop B	Relay B : Pulse on loop B	Relay B : Pulse on loop B	Relay B : Pulse on loop A
DS#8	Relay B : Pulse on loop A entry	Relay B : Pulse on loop A exit	Relay B : Pulse on loop B entry	Relay B : Pulse on loop B exit	Relay B : Pulse on loop entry	Relay B : Pulse on loop exit
DS#9	100 ms	500 ms	100 ms	500 ms	100 ms	500 ms
DS#10	Not used	Not used	Independent	Combined mode	Independent	Combined mode

II. POTENTIOMETERS

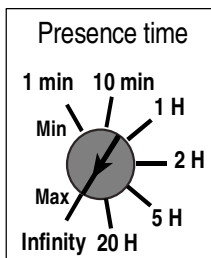

FIG. 1

- A potentiometer for adjustment of the maximum duration of a presence detection : from 1 min to infinity ; (see Fig. 1)
- A potentiometer for adjustment of the linear sensitivity (Δf) for the loop A : from 0.005% to 0.5 % ; (see Fig. 2)
- A potentiometer for adjustment of the linear sensitivity (Δf) for the loop B : from 0.005% to 0.5 %. (see Fig. 2)

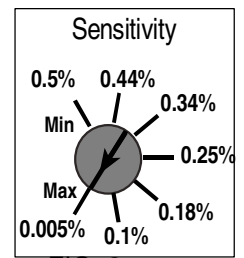

FIG. 2

DIPSWITCH SETTINGS

A 10 position dip switch is located on the front of the Matrix single detector. Dip switch 3, 5, 6, 7, and 8 configure the relay, while dip switch 9 controls the duration of the pulse when the Matrix is configured for pulse operation, (as opposed to presence). Configurations are as follows:

Dip Switch 3:

OFF= FAIL-SECURE MODE Relay is NOT energized when power is applied. Relay is energized upon detection only. In this mode, the N.O. circuit is open, and the N.C. circuit is closed. Thus, if a closed circuit is required upon detection, one must use the N.O. and COM terminals since they would close upon detection. When the Matrix is NOT powered, it is in the same state as it would be for non-detection.

ON = FAIL-SAFE MODE Relay is energized as soon as power is applied, and de-energizes upon detection or power loss. In this mode, upon powering the detector, the N.O. circuit becomes closed, and the N.C. circuit becomes open. Thus, if a closed circuit is required upon detection, one must use the N.C. and COM terminals, since they would now be OPEN during non-detection, and would close upon detection. When the Matrix is NOT powered, it is in the same state as it would be for detection.

Detection Status	Fail-Secure Mode (Active Mode) (Relay is not energized upon power-on) Dipswitch 3 OFF	Fail-Safe Mode (Passive Mode) (Relay becomes energized upon power-on) Dipswitch 3 ON
No Detection	The COM and N.O. terminals are OPEN. COM and N.C. terminals are CLOSED. The relay is de-energized.	The COM and N.O. terminals are CLOSED. COM and N.C. terminals are OPEN. The relay is energized.
Detection	The COM and N.O. terminals are CLOSED. COM and N.C. terminals are OPEN. The relay is energized.	The COM and N.O. terminals are OPEN. COM and N.C. terminals are CLOSED. The relay is de-energized.
Upon Power Loss	The COM and N.O. terminals are OPEN. COM and N.C. terminals are CLOSED The relay is de-energized.	The COM and N.O. terminals are OPEN. COM and N.C. terminals are CLOSED. The relay is de-energized.

DIPSWITCH SETTINGS

III. DIP SWITCHES

After each dip switch change the sensor launches a learning process.

Dip Switch #1	Frequency Adjustments of Loop A (see ADJUSTMENTS on the next page)
Dip Switch #2	Frequency Adjustments of Loop A (with single loop) or Loop B (with dual loops)
Dip Switch #3	Relay configuration : active (fail-secure) or passive (fail-safe_ (see above)
Dip Switch #4	Automatic Sensitivity Boost (ASB option) [recommended for improved truck detection] : During a detection, the sensitivity increases automatically to 8 times the preset sensitivity given by the sensitivity potentiometer adjustment. It is limited to the maximum sensitivity ($\Delta f = 0.005\%$). It goes back to the preset value after detection stops.
Dip Switch #5	Relay A function : presence or pulse (not used with dual loop in combined mode)
Dip Switch #6	Relay A Pulse type : entry or exit (used only at pulse function) or Relay B mode (with dual loop in combined mode) (see drawing on next page) <ul style="list-style-type: none"> • Non-Directional : Relay B provides a pulse according to the dip switches #7 and #8 setting. • Directional A→B : Relay B provides a pulse only if loop A is detecting before loop B. The logic detection takes place according to dip switches #7 and #8. <div style="border: 1px solid black; padding: 5px; margin-top: 10px;"> <p>Warning : During the detection, the 2 loops have to detect simultaneously for a short period to be able to determine the movement direction. During loop installation make sure the 2 loops are close enough to each other to ensure a common detection (typical 3 feet).</p> </div>
Dip Switch #7	Relay B function : presence or pulse Or loop selection for relay B pulse : pulse on Loop B or pulse on Loop A (used with dual loop in combined mode)
Dip Switch #8	Relay B Pulse type : entry or exit (used only at pulse function)
Dip Switch #9	Pulse duration for both relays (used only at pulse function): 100 ms or 500 ms
Dip Switch #10	Dual loop mode : independent or combined A→B (not used with single loop)

ADJUSTMENTS

Frequency adjustment for loop A for single loop detector		
Dip Switch #1	Dip Switch #2	Loop frequency
OFF	OFF	High
ON	OFF	Mid High [High -20%]
OFF	ON	Mid Low [High - 25%]
ON	ON	Low [High - 30%]

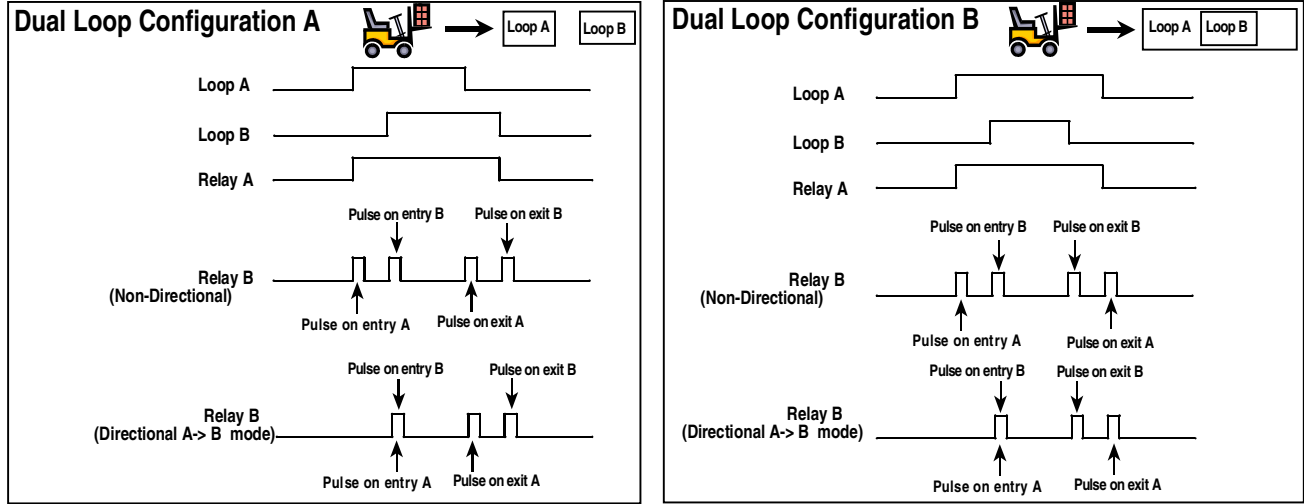

LED SIGNAL

Green LED shows when the module is powered;
Red LED gives:

- the corresponding loop detection state in normal situation;
- the value of the oscillation frequency measurement or an error message on power ON.

Normally, the red LED stays ON as long as the loop is in a state of detection.

On **POWER ON**, the sensor measures the oscillation frequency of each loop. The result of this measurement is displayed using the corresponding red LED. The number of flashes indicates the tens value of the frequency. For example 4 short flashes correspond to a frequency between 40 kHz and 49 kHz. After this message the LED goes back to normal display.

If the loop oscillation frequency falls outside the limits (20 kHz to 130 kHz) the red LED displays an error message and the sensor activates the corresponding relay. The blinking frequency shows the type of error according to the next table. The sensor will stay in error mode until the error is cleared and the frequency goes to the right range.

Remark : The sensor launches automatically a learning process if the oscillation frequency varies more than 10% in comparison with the measurement value.

Loop frequency error	LED display
Oscillation frequency too LOW or loop opened	LED blinking at 1Hz
Oscillation frequency too HIGH	LED blinking faster at 2 Hz
Loop shorted or no oscillation	LED blinking slower at 0.5 Hz

**TROUBLE-
SHOOTING**

<i>SYMPTOM</i>	<i>PROBABLE CAUSE</i>	<i>CORRECTIVE ACTION</i>
The loop detector will not work. The green LED is off.	There is no power supply to the loop detector.	Check power supply.
The loop detector will not work. The red LED is flashing slowly (0.5 Hz).	The corresponding loop is shorted.	Check the loop cable.
The loop detector will not work. The red LED blinks at either 1Hz or 2Hz.	The frequency of oscillation falls outside the allowed range.	Adjust frequency with dip switches or change loop turns.
The loop LED is detecting properly but the contact is not made.	Bad connection of the relay contacts.	Check relay connections.
Dip switches 5 to 8 are not responding properly.	Their function varies according to dip switch #10 setting.	Check the appropriate loop mode required and adjust dip switch #10.

**COMPANY
CONTACT**

If after troubleshooting a problem, a satisfactory solution cannot be achieved, please call B.E.A., Inc. for further assistance during **Eastern Standard Time at 1-800-523-2462 from 8am - 5pm.**
For after-hours, call East Coast: 1-866-836-1863 / Mid-West: 1-888-308-8843
West Coast: 1-888-419-2564. **DO NOT leave any problem unresolved.** If you must wait for the following workday to call B.E.A., leave the door inoperable until satisfactory repairs can be made.
NEVER sacrifice the safe operation of the automatic door or gate for an incomplete solution.
Web: www.beasensors.com